

Sistemas de barandas modulares

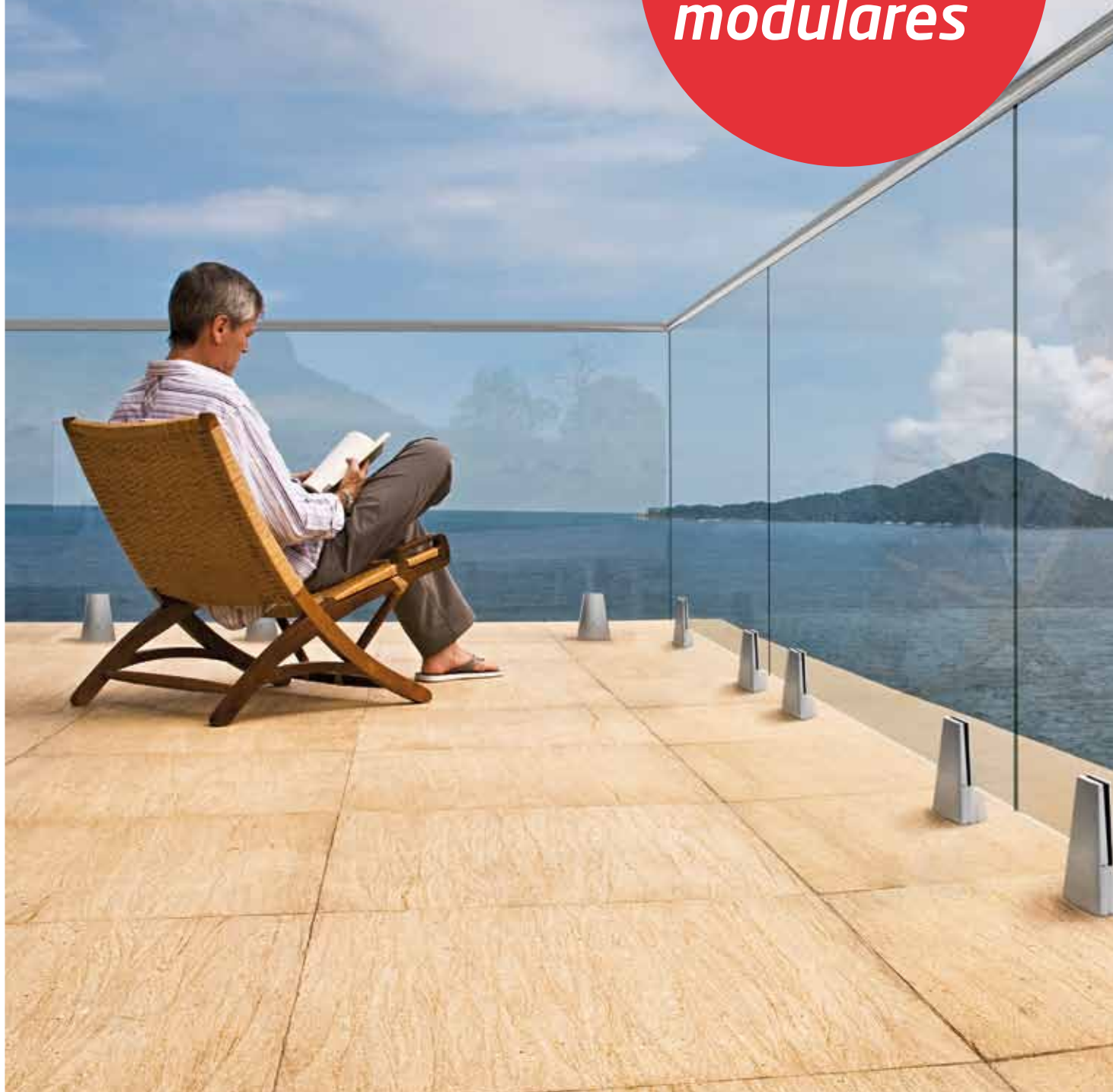













2014/2015

HERRALUM[®]
líder en herrajes para aluminio y vidrio

comenza
Railing Passion

GLOSARIO /

E	Espesor del tubo
G	Espesor del cristal
L/R	Izquierda/derecha
M	Métrica del tornillo
Pcs/Box	Piezas por caja
LG	Largo
Ø A	Diámetro del tubo 1
Ø B	Diámetro del tubo 2
Ø	Diámetro
Ref	Referencia
D	Espaciado del cristal

	Pegamento
	Atornillar
	Atornillar con llave allen
	Fijación con resina química
	Llave gancho
	Llave pitones
	Bandeador
	Tornillo DIN 912
	Tornillo DIN 7991
	Tuerca remachable
	Anclaje metálico MT
	Anclaje metálico CH
	Tacos premontados

ÍNDICE /

06



GLASSFIT NEW GENERATION

- 06. SISTEMA DE PINZAS VIDRIO PARA SUELO
- 08. ADAPTADOR LATERAL VIDRIO
- 10. SOPORTE PASAMANOS VIDRIO

12



GLASSFIT

- 12. PINZAS VIDRIO

14



R-CONCEPT

- 14. BASES SUELO, BASES PARED Y EMBELLECEDORES
- 18. SOPORTES LATERAL PARA BARANDALES
- 19. TAPONES Y REMATES FINALES
- 20. SOPORTES TRANSVERSALES
- 21. SOPORTES TUBO
- 22. CODOS Y CONECTORES DE TUBO

24



EASYCABLE

- 24. ACCESORIOS PARA CABLE INOX.

25



HANDRAIL

- 26. SOPORTE PASAMANOS PARED

28



BRICO

- 28. COMPLEMENTOS

30



DESIGN

- 32. GALERIA DE PROYECTOS





*Pasión por
el diseño*



HERRALUM
líder en herrajes para aluminio y vidrio



comenza
Railing Passion

Comenza es la compañía global de sistemas de barandillas de diseño que proporciona soluciones creativas a las necesidades de las personas en los espacios que habitan, a través de productos de alta calidad que garantizan su seguridad y su bienestar.



*CC-780:
Pura Transparencia*

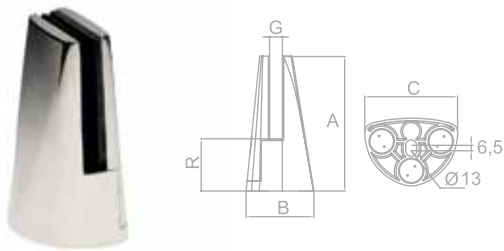

CC 780 SATIN AISI-304

pcs/box	A	B	C	R	G
1	160	80	110	60-65	(12-17,52)



Para consulta de los parámetros de modulación solicita las tablas de uso del sistema CC-780 en herralum@herralum.com

Carga lineal: **0,8 kN/m**

M12

Vídeo de ensayo físico disponible en:
www.comenza.com

1380022

CONECTOR BASE P/BARANDAL 10 - 17.5 MM DE ESPESOR
ACERO INOX 304 MOD CC780 **SATINADO**



BR-2031

pcs/box	Ø
1	11 a 60

LLAVE PITONES PARA CC-780

1380105

LLAVE PITONES PARA AJUSTE MOD BR2031 PARA
HERRAJE 1380022 (CC 780)

Instalación



Sistema de nivelación del vidrio con tres puntos (regula los ejes XYZ)

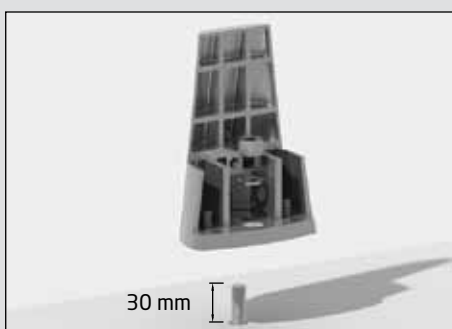



CC-775: La elegancia de lo simple

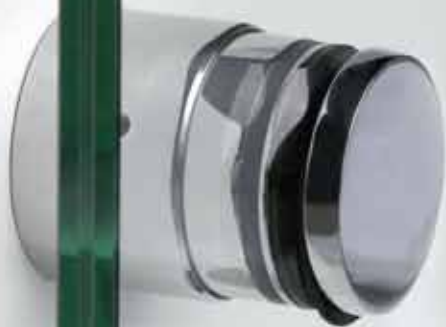

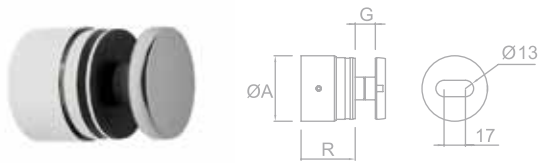

CC 775 SATIN AISI-304

pcs/box	ØA	R	G
2	52	45-50	(8-21,52)



Para consulta de los parámetros de modulación y anclaje solicita las tablas de uso del sistema CC-775 en herralum@herralum.com

Carga lineal: **1 kN/m** **M 10-M12** **Ø19-24**

Vídeo de instalación y ensayo físico disponibles:
www.comenza.com

1380017

CONECTOR AC INOX 304 PARA VIDRIO
MOD CC775 **SATINADO**



BR-2030

pcs/box	Ø
1	45-50mm

LLAVE DE GANCHO PARA CC-775

1380104

LLAVE GANCHO P/AJUSTE
MOD CC775 45-50mm

Instalación

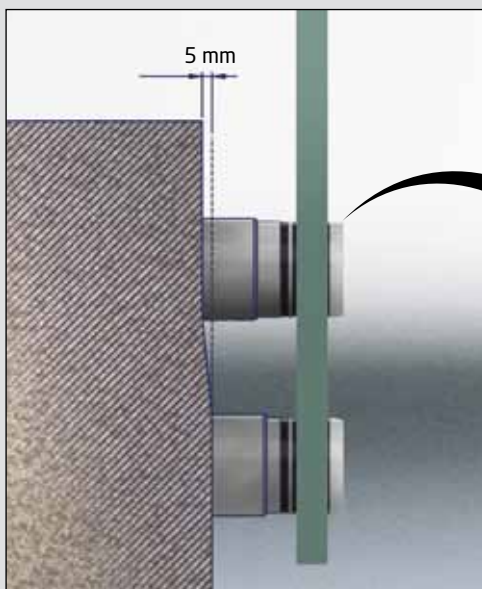

Sistema nivelador del vidrio

La CC-775 está dotada de un sistema de ajuste para evitar irregularidades de la superficie. Mantener siempre la marca de ajuste en el interior de la pieza.

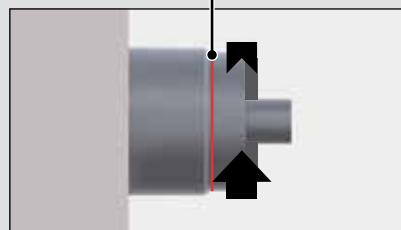

Diseño y transparencia

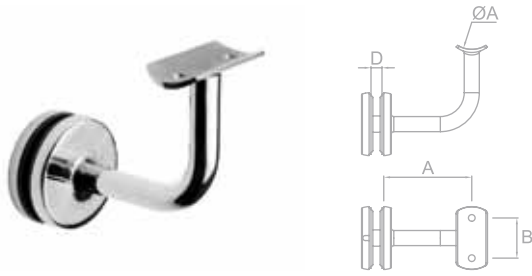

ST 314 SATIN AISI-304

pcs/box	ØA	A	B	D
2	50,8	70	32	(6-21,52)

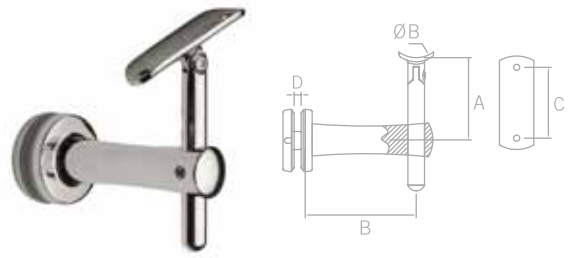

SA 423 (BG R) SATIN AISI-304

pcs/box	ØA	A	B	C	D
2	50,8	30-70	80	61,5	(6-17,52)



1380016

SOPORTE LATERAL 50.8mm AC INOX 304
MOD ST314 **SATINADO**

1380028

SOPORTE AJUSTABLE 50.8mm AC INOX 304
MOD SA423 **SATINADO**

Instalación

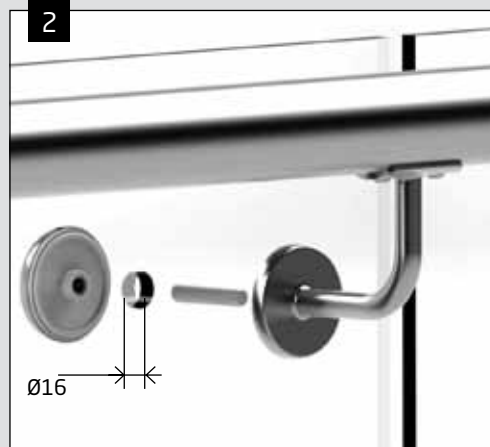



Pinzas de vidrio con tope de seguridad, el vidrio no necesita ser taladrado

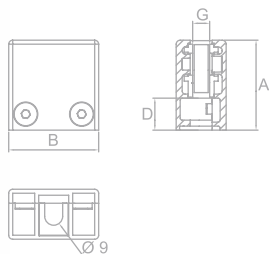

CC 724 SATIN AISI-304

pcs/box	A	B	D	G
4	45	45	16	(6-10,76)

Din-912 M-8 L-20

BR-2011 M-8

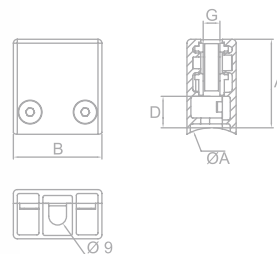

CC 725 SATIN AISI-304

pcs/box	øA	A	B	D	G
4	50,8	45	45	16	(6-10,76)

Din-912 M-8 L-20

BR-2011 M-8



1380010

CONECTOR GRAPA BASE PLANA 8-10
MOD CC724 SATINADO

1380011

CONECTOR GRAPA 50.8mm CURVO 8-10
MOD CC725 SATINADO



Consultar BRICO / Página 28

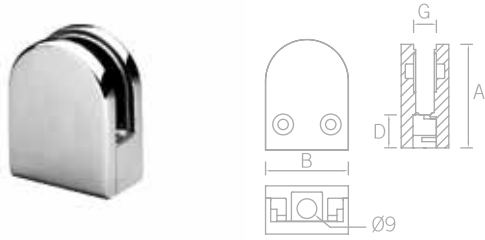

CC 700 SATIN AISI-304

pcs/box	A	B	D	G
4	50	40	16	(8-10)
4	50	40	16	(10-12)

Din-912 M-8 L-20	
------------------	--

1380029

CONECTOR GRAPA PLANO 8-10
MOD CC700 **SATINADO**

1380030

CONECTOR GRAPA PLANO 10-12
MOD CC700 **SATINADO**



Vídeo de instalación disponible: www.comenza.com

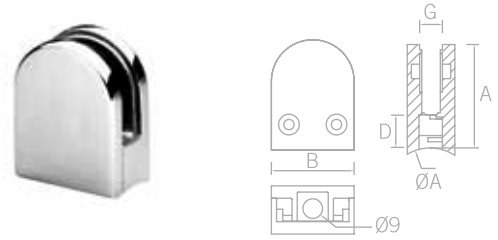

CC 701 SATIN AISI-304

pcs/box	øA	A	B	D	G
4	38,1	50	40	16	(8-10)
4	50,8	50	40	16	(8-10)
4	38,1	50	40	16	(10-12)
4	50,8	50	40	16	(10-12)

Din-912 M-8 L-20	
------------------	--

1380031

CONECTOR GRAPA 38.1mm CURVO 8-10
MOD CC701 **SATINADO**

1380031

CONECTOR GRAPA 50.8mm CURVO 8-10
MOD CC701 **SATINADO**

1380032

CONECTOR GRAPA 38.1mm CURVO 10-12
MOD CC701 **SATINADO**

1380032

CONECTOR GRAPA 50.8mm CURVO 10-12
MOD CC701 **SATINADO**

Instalación



[img.1]



[img.2]



[img.3]



Los detalles son importantes

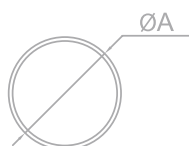

TUBO REDONDO SATIN AISI-304

	LG	ØA		
2251012	6000 1/2	12,7	CAL20	SATINADO
2252112	6000 1 1/2	38,1	CAL18	SATINADO
2252200	6000 2"	50,8	CAL18	SATINADO

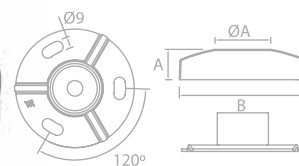

AV 603 SATIN AISI-304

pcs/box	ØA	A	B	E*
2	38,1	22,5	99	1,5
2	50,8	22,5	99	1,5



1380002

BASE CON TAPA 50.8mm AC INOX 304

MOD AV603 **SATINADO**

1380002

BASE CON TAPA 38.1mm AC INOX 304

MOD AV603 **SATINADO**



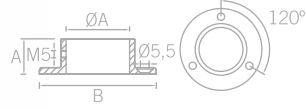

AV 601 SATIN AISI-304

pcs/box	ØA	A	B
2	50,8	31	102

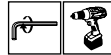

1380001

BASE SIN TAPA 50.8mm AC INOX 304
MOD AV601 **SATINADO**

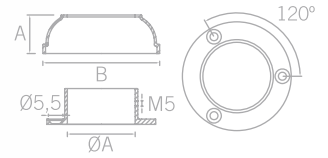

AV 602 SATIN AISI-304

pcs/box	ØA	A	B
2	38,1	25	73
2	50,8	29	85

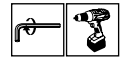

1380035

BASE CON TAPA 38.1mm AC INOX 304
MOD AV602 **SATINADO**

1380035

BASE CON TAPA 50.8mm AC INOX 304
MOD AV602 **SATINADO**





Soluciones de diseño a tus necesidades funcionales



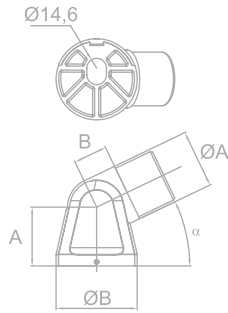

SA 451 SATIN AISI-304

pcs/box	ØA	ØB	A	B	α
2	38,1	60	43,5	25	26-90
2	50,8	60	43,5	25	26-90

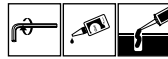

1380013

BASE CONECTOR AJUSTABLE 38.1 MM

MOD SA451 **SATINADO**

1380013

BASE CONECTOR AJUSTABLE 50.8 MM

MOD SA451 **SATINADO**



Instalación



Sistema de base regulable para rampas

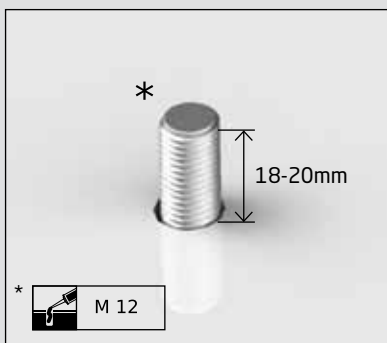

[img.1]



[img.2]

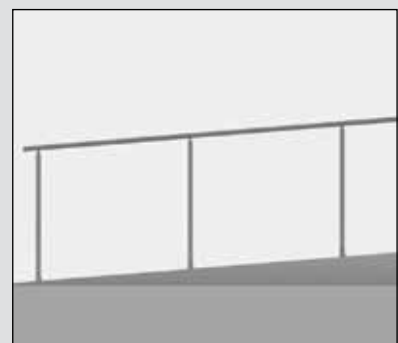

[img.3]



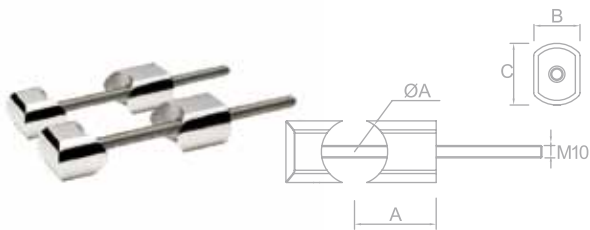

¡Innovación conseguida!

**SL 1120 SATIN AISI-304**

pcs/box	ØA	A	B	C
1 kit*	38,1	51	25	30
1 kit*	50,8	57	30	40

1Kit*: 2pcs

**1380015**

SOPORTE LATERAL 38.1mm AC INOX 304

MOD SL1120 **SATINADO****1380015**

SOPORTE LATERAL 50.8mm AC INOX 304

MOD SL1120 **SATINADO**

Instalación



Separación vertical recomendada entre puntos de anclaje: 100mm



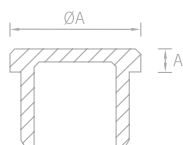

TF 502 SATIN AISI-304

pcs/box	$\varnothing A$	A	E*
2	12,7	2	1,5
2	38,1	2	1,5
2	50,8	2	1,5

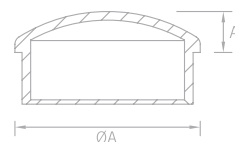

TF 505 SATIN AISI-304

pcs/box	$\varnothing A$	A	E*
2	38,1	19,5	1,5
2	50,8	25	1,5



1380009

TAPA PLANA 12.7mm AC INOX 304
MOD TF502 **SATINADO**

1380009

TAPA PLANA 38.1mm AC INOX 304
MOD TF502 **SATINADO**

1380009

TAPA PLANA 50.8mm AC INOX 304
MOD TF502 **SATINADO**

1380036

TAPA CURVA 38.1mm AC INOX
MOD TF505 **SATINADO**

1380036

TAPA CURVA 50.8mm AC INOX
MOD TF505 **SATINADO**

Instalación



Pegamento estructural Easy-Fix



[img.1]



[img.2]



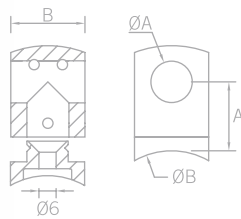
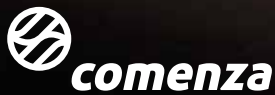

Acabado perfecto Trabajo resuelto



ST 320 SATIN AISI-304

pcs/box	øA	øB	A	C
4	12,7	38,1	20	21
4	12,7	50,8	20	21

 Din-7991 M-6 L-20

 BR-2011 M-6



Vídeo de instalación disponible: www.comenza.com

1380014

CONECTOR BASE CURVA AJUSTABLE PARA 38.1 Y 50.8 MM
CON ENTRADA PARA 1/2" MOD ST 320 SATINADO

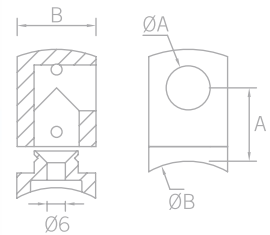

ST 322 SATIN AISI-304

pcs/box	øA	øB	A	C	L/R
4	12,7	38,1	20	21	Left
4	12,7	38,1	20	21	Right
4	12,7	50,8	20	21	Left
4	12,7	50,8	20	21	Right

 Din-7991 M-6 L-20

 BR-2011 M-6



1380023

CONECTOR FINAL 38.1mm IZQ MOD ST322 SATINADO

1380023

CONECTOR FINAL 50.8mm IZQ MOD ST322 SATINADO

1380024

CONECTOR FINAL 38.1mm DER MOD ST322 SATINADO

1380024

CONECTOR FINAL 50.8mm DER MOD ST322 SATINADO

*Atornillar y pegar:
¡no es necesario soldar!*

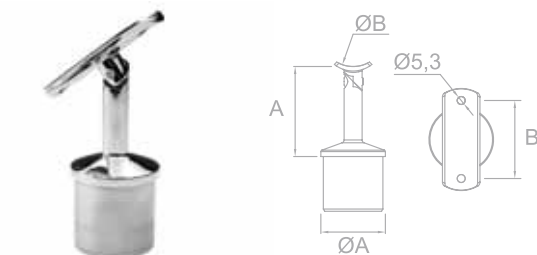

SA 404 SATIN AISI-304

pcs/box	øA	øB	A	B	E*
2	38,1	50,8	55	48	1,5
2	50,8	50,8	65	60	1,5



1380008

SOPORTE AJUSTABLE 38.1mm AC INOX 304

MOD SA404 **SATINADO**

1380008

SOPORTE AJUSTABLE 50.8mm AC INOX 304

MOD SA404 **SATINADO**

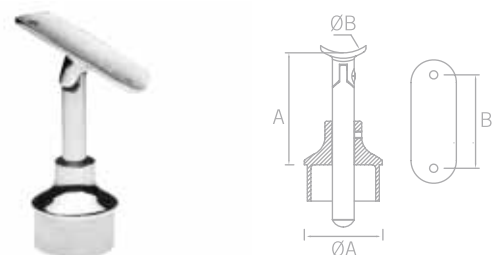

SA 420 (BG-R) SATIN AISI-304

pcs/box	øA	øB	A	B	E*
2	50,8	50,8	30-100	61,5	1,5



1380012

SOPORTE AJUSTABLE 50.8 MM ACERO INOX 304

CON AJUSTE DE ALTURA MOD SA 420 (BG-R) **SATINADO**



Las uniones ya no son un problema



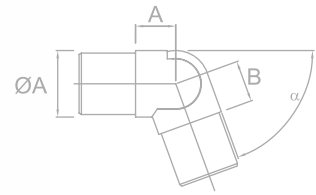
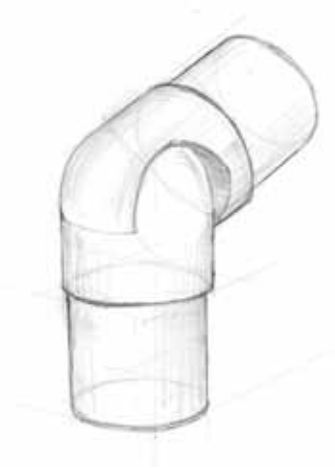

SA 406 SATIN AISI-304

pcs/box	ØA	A	B	E*	α
2	12,7	8	8	1,5	0-90
2	50,8	32	32	1,5	0-70



1380007

CODO AJUSTABLE 12.7mm AC INOX 304
MOD SA406 **SATINADO**

1380007

CODO AJUSTABLE 50.8mm AC INOX 304
MOD SA406 **SATINADO**

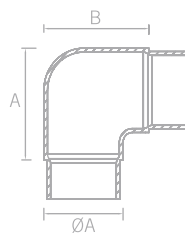

CT 200 SATIN AISI-304

pcs/box	ØA	A	B	E*
2	50,8	60	60	1,5



1380003

CODO RECTO 50.8mm AC INOX 304 A 90°
MOD CT200 **SATINADO**

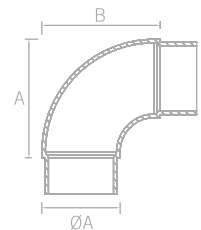

CT 201 SATIN AISI-304

pcs/box	ØA	A	B	E*
2	50,8	60	60	1,5



1380004

CODO CURVO 50.8mm AC INOX 304 A 90°
MOD CT201 **SATINADO**

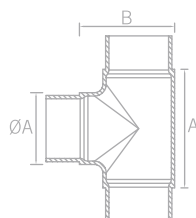

CT 202 SATIN AISI-304

pcs/box	ØA	A	B	E*
2	50,8	69	60	1,5



1380005

CODO RECTO 50.8mm AC INOX 304 TIPO "T"
MOD CT202 **SATINADO**

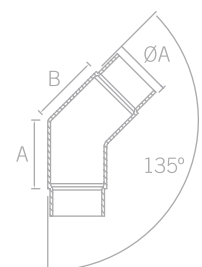

CT 207 SATIN AISI-304

pcs/box	ØA	B	E*
2	50,8	4	1,5



1380006

UNION DE TUBO 50.8mm AC INOX 304
MOD CT207 **SATINADO**



Rápido y fácil de instalar: tu mejor opción en sistemas de barandillas de cable



SC 800 SATIN AISI-304

pcs/box	ØC	B
2	4 mm	112



SC 801 SATIN AISI-304

pcs/box	ØC	B
2	4 mm	71



1380025

CONECTOR TENSOR LARGO AC INOX 304 PARA CABLE
4 MM DIAMETRO MOD SC 800 **SATINADO**

1380026

CONECTOR TENSOR CORTO AC INOX 304 PARA CABLE
4 MM DIAMETRO MOD SC 801 **SATINADO**



Cable Inox.

∅C	L
4 mm	Consultar



1380027

CABLE TENSOR AC INOX 316 DE 4 MM (50 MTS)

Vídeo de instalación disponible: www.comenza.com

Resistencia a la tracción hasta una carga máxima de 250 Kg.

Ensayado por: **aimen** CENTRO TECNOLÓGICO

Recomendaciones ▼

Cable Recomendado/  7+7+0 semi-flexible

[Recomendaciones]

(Los datos reflejados están basados en ensayos realizados con cálculo elementos finitos y verificados en nuestras instalaciones con ensayos físicos. Es responsabilidad del usuario establecer la idoneidad de la información facilitada con el uso particular que vaya a realizar del producto)

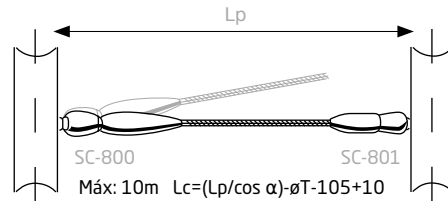

Lc=Longitud del cable
 Lp=Longitud entre centros de pilares
 ∅T=∅ tubo
 K=105 mm
 D=10 mm

Instalación ▼



[img.1]



[img.2]

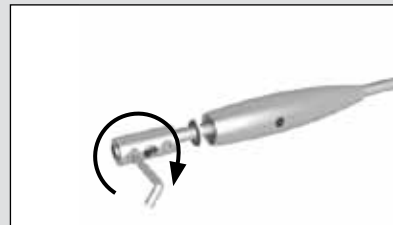

[img.3]

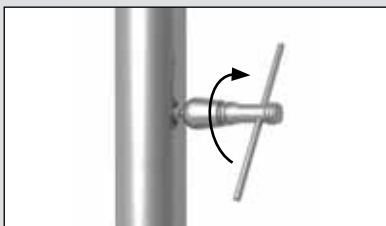

[img.4]

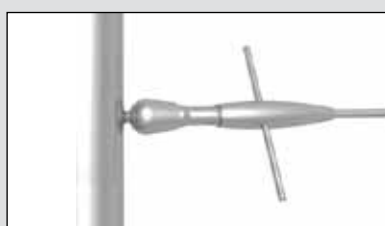

[img.5]



[img.6]



Pasamanos con personalidad Comenza



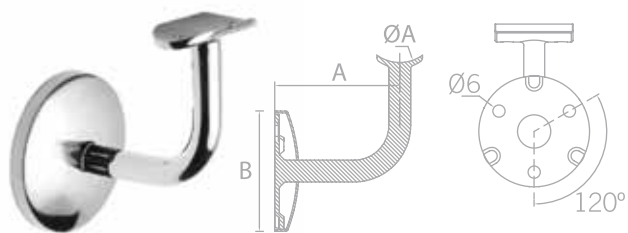

ST 353 SATIN AISI-304

pcs/box	ØA	A	B
2	50,8	69	66



1380037

CONECTOR PASAMANOS 50.8mm AC INOX 304
MOD ST353 **SATINADO**

Instalación



[img.1]



[img.2]



[img.3]

**EASY-FIX GLUE (Pegamento) 50ml**

pcs/box

1

1380100

ADHESIVO P/ AC INOX JF-GLUE 50ml

Características Easy-Fix Glue

- Envase monocomponente
- Velocidad de secado:
Curado inicial 2-3 minutos / 50% sujeción 45 min / 100% sujeción 24h.
- Cubre holguras de hasta 3mm
- Cantidad: 50ml
- Temperatura de conservación: 15-25°
- Duración aproximada:

ø50,8 mm	ø43 mm	ø38 mm	ø20 mm	ø12 mm
40	50	60	120	150

**CLEAN + (Limpiador acero inox) 500ml**

pcs/box

1

Consulta instrucciones de uso en: herralum@herralum.com**1380101**

LIMPIADOR AC INOX JF-CLEAN+ 500ml

**STAIN ZERO (Quitaóxido) 500ml**

pcs/box

1

Consulta instrucciones de uso en: herralum@herralum.com**1380102**

QUITAOXIDO JF-STAIN ZERO 500ml



BR-2011

pcs/bolsa	CALIDAD	M
10	A-2	M-6
10	A-2	M-8

M6
Serie ST: ST-320, ST-322
M8
Serie CC: CC-700, CC-701, CC-724, CC-725

1380018

BOLSA TUERCA AC INOX REMACHABLE M6 C/BAJA SATINADO

1380019

BOLSA TUERCA AC INOX REMACHABLE M8 C/BAJA SATINADO

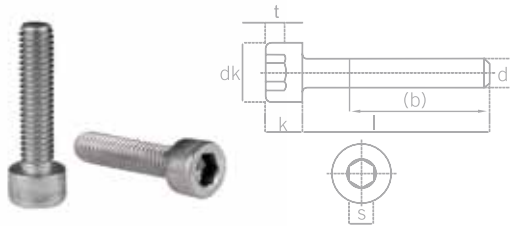

DIN 912

pcs/bolsa	CALIDAD	M
10	A-2	M-8

DIN 912 M8 L-20
Serie/series/série CC: CC-700, CC-701, CC-724, CC-725

1380021

BOLSA TORNILLO AC INOX C/C ALLEN M8 DIN912 SATINADO



BR-2030

pcs/box	∅
1	45-50mm

45-50
Serie/series/série CC: CC-775, ST-314, SA-423

1380104

LLAVE GANCHO P/AJUSTE MOD CC775 45-50mm



DIN 7991

pcs/bolsa	D	L	CALIDAD
10	M-6	20	A-2

DIN 7991 M6 L-20
Serie ST: ST-320, ST-322

1380020

BOLSA TORNILLO AC INOX C/P ALLEN M6 DIN7991 SATINADO

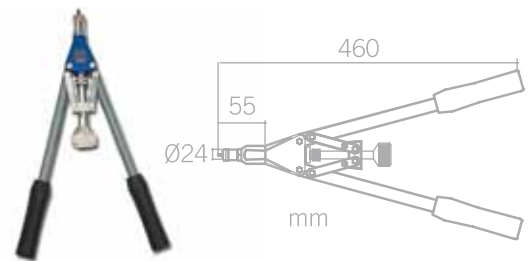

TR-208

pcs/box	PESO		
1	1600gr.		
∅ mm	Aluminio	Acero	Inox
M-4	✓	✓	✓
M-5	✓	✓	✓
M-6	✓	✓	✓
M-8	✓	✓	✓

1380103

REMACHADORA TR-208



BR-2031

pcs/box	∅
1	11-60mm

LLAVE PITONES
Serie/series/série CC: CC-80

1380105

LLAVE PITONES P/AJUSTE MOD BR2031 PARA HERRAJE 1380022 (CC 780)

Design 

lo hacemos real,
lo hacemos posible

GlassFit New Generation

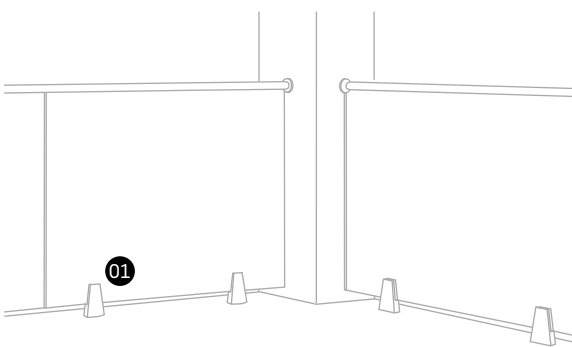

01 CC-780









GlassFit New Generation

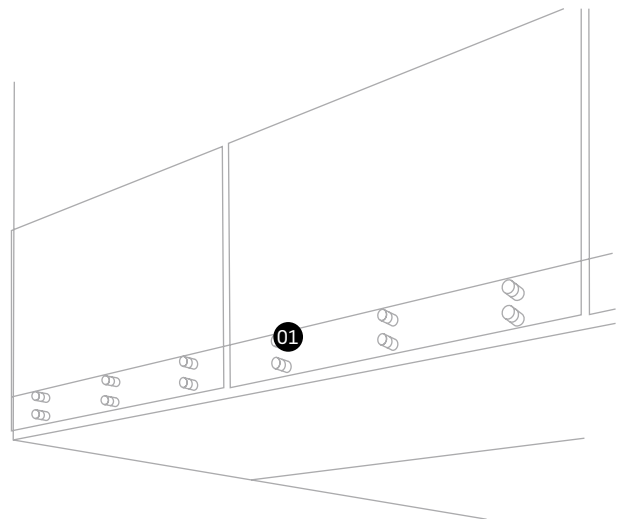

01 CC-775



SA-423

GlassFit

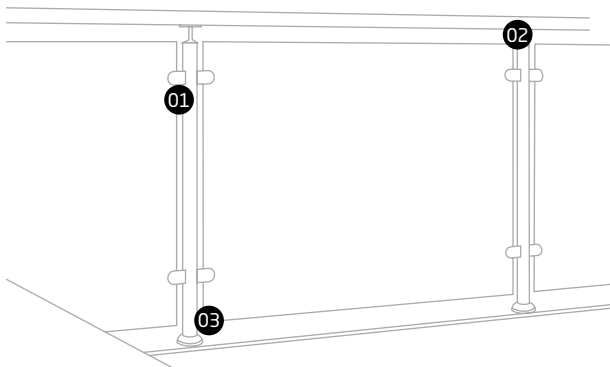

01 CC-701



02 SA-404



03 AV-603









R-Concept

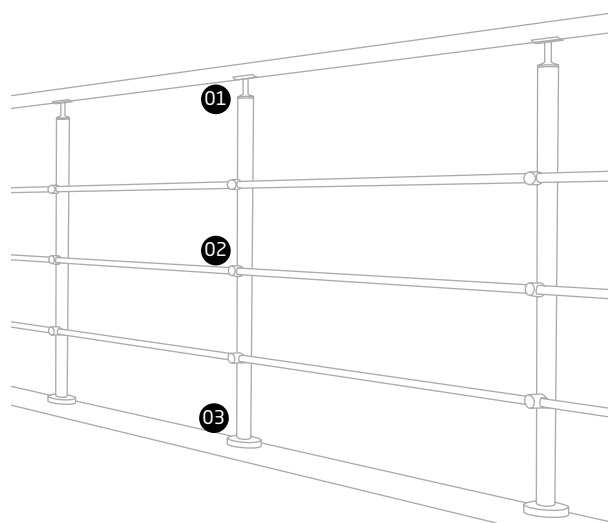

01 SA-404



02 ST-320



03 AV-603

EasyCable

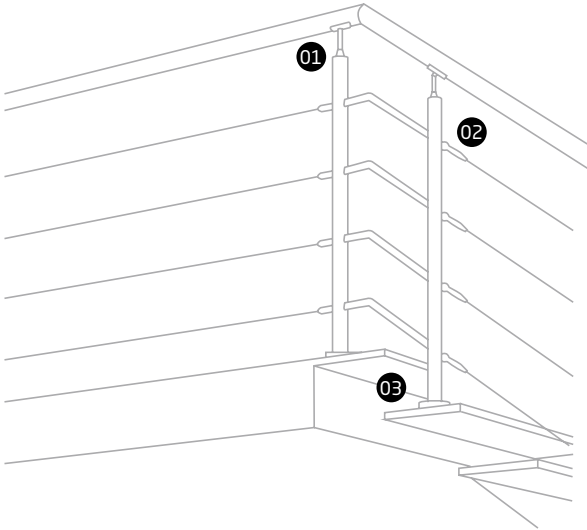

01 SA-404



02 SC-800



03 AV-603





Los datos técnicos mostrados en este catálogo sólo tienen carácter informativo y por lo tanto los productos originales pueden diferir ligeramente de las medidas e ilustraciones fotográficas.

Comenza se reserva el derecho a realizar cambios y mejoras en los productos mostrados en este catálogo siempre que lo estime oportuno.





HERRALUM®
líder en herrajes para aluminio